

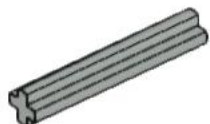

2x
32072, 11



1x
32034, 6



2x
4519, 9



1x
32034, 7



4x
32062, 5



2x
32056, 3

1

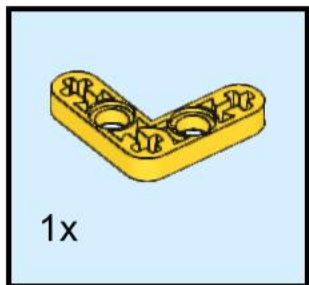

2

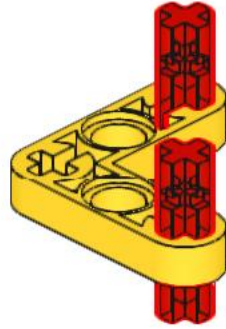
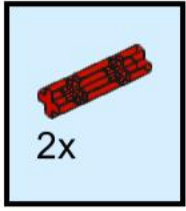

3

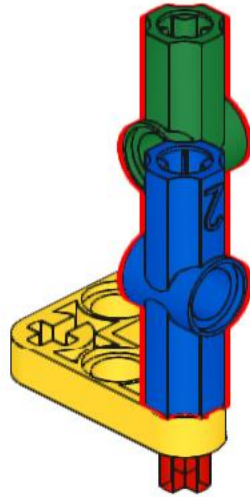
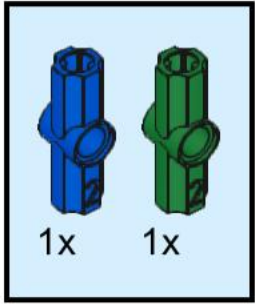

4

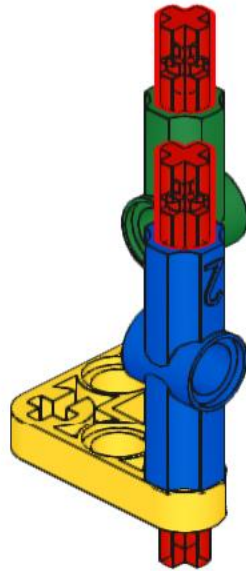
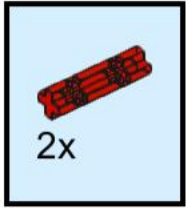

5

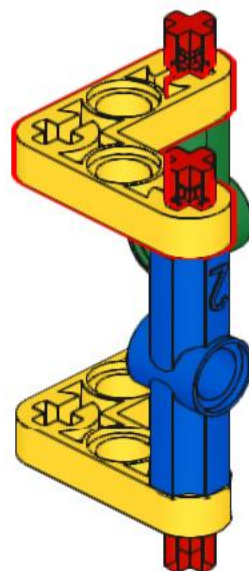
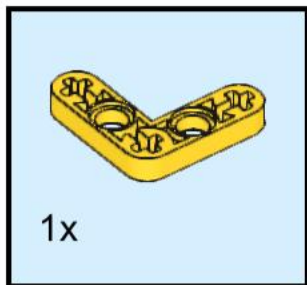

6

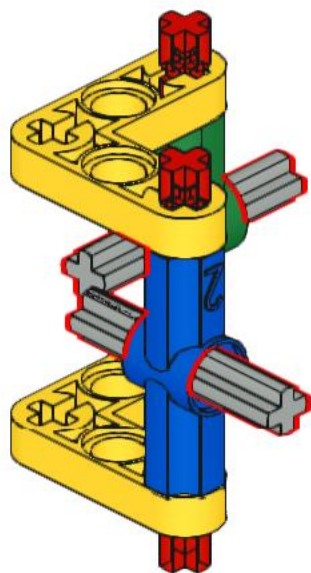
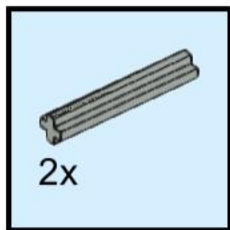

7

